

blu**rams**

Outdoor Lite 3 S21C



Manual & Guide

# Packing List



1 × Camera

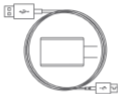

1 × Power Cord

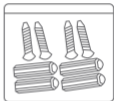

1 × Screws Accessories  
Kit



1 × Waterproof Case



1 × User Manual

## Get to know your camera

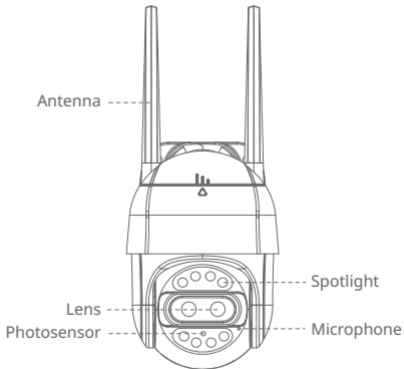

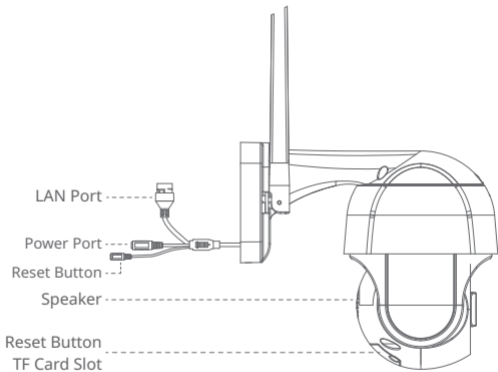

Please cut the power off when inserting/removing your SD card to ensure it can be recognized.

## 1. Power up your camera

For the normal operation of the camera, please use the provided power cord to charge it.

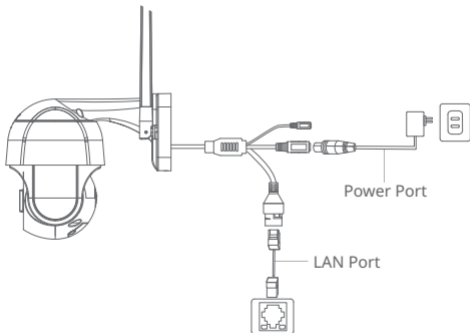

The camera has a power port and a LAN port. Waterproofing must be done on both of these ports.

1. Wrap the power port with waterproofing tape (self-provided) as shown below.
2. Wrap the LAN port with the waterproofing tape (self-provided) or the waterproofing case.

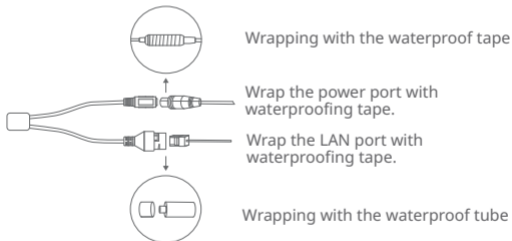

## 2. Download blurams App

Download the App by searching "blurams" in the App Store or Google Play. Alternatively, you can open a QR scanner App and scan the blurams App QR code below to install the App.



blurams App QR code



### 3. Add your camera to App

Enter the blurams App, sign up for a free blurams account and log in. Go to the home page, click the "+" icon on the top right corner and select the model of your camera. Then follow the instructions to finish the device configuration.

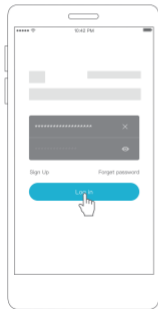



## FAQs

### **Why I can't add the camera to the App?**

1. Make sure the camera powers on and the red and the blue lights flash alternatively to finish self-examination, then you can add the camera.
2. Connect your smartphone and the camera to the same 2.4GHz Wi-Fi network (5GHz network is not supported currently).
3. Keep the camera, phone, and Wi-Fi router as close as possible during pairing.

### **Why the captured video is black and white?**

1. Position the camera in a well-lit environment during the daytime.
2. Check "Preferences" to see if the night vision is ON.
3. Restart the camera.
4. If you continue seeing black and white or other abnormal colors after trying all the above solutions, please contact the support team for help.

### **Why won't the camera be turned on?**

1. Use the original blurams power adapter and cord.
2. Try using another power adapter and cord.
3. If the problem persists, contact the support team for help.

### **Why is the live streaming video upside down?**

In the blurams App, go to the device's "Preferences" and tap "Rotate 180°".

If you encounter any other problems in Product Information, Product Installation and Use, please refer to the "Mine > Help And Feedback" in the blurams App or email [support@blurams.com](mailto:support@blurams.com).

### **Why can't the camera scan the QR code?**

1. Make sure there is no dust on the lens.
2. Adjust the smartphone screen brightness to high.
3. Tap the QR code picture to enlarge it.
4. Adjust the distance between the lens and screen, the optimal distance is 3-5in.

### **Can't hear sound from the camera?**

1. Check "Preferences" to turn "Microphone" option on.
2. Try to talk closer and louder to the camera.
3. Restart the camera.

**Please cut the power off when inserting/removing your SD card to ensure it can be recognized.**

**We recommend connecting the camera with an Ethernet cable to get stabler and better network connection**

### **Look forward to your feedbacks**

blurams strives for offering high-quality products and thoughtful user experience, and we're eager to hear your feedback or suggestions. Feel free to send your feedback through the App or email at [support@blurams.com](mailto:support@blurams.com).



## Notes:

1. Please cut the power off when inserting/removing your SD card to ensure it can be recognized.
2. Do not use the camera in any extreme weather environments such as extremely high, low temperatures, direct strong sunlight, or heavy rain for long periods of time. The suitable temperature for the product and accessories is -20 °C to 60 °C.
3. If you use a third-party charger, the recommended output voltage/current of the adaptor is DC 12V/1A, and the adapter should be CE approval type.
4. RF Exposure Information: The Maximum Permissible Exposure (MPE) level has been calculated based on a distance of  $d=20\text{cm}$  between the device and the human body. To maintain compliance with RF exposure requirements, use products that maintain a 20cm distance between the device and the human body.
5. Operating Frequency Range: 2412 MHz ~ 2472 MHz Max Output Power: < 20dBm
6. This product can be used across EU member states.

## **FCC Statement**

This equipment has been tested and found to comply with the limits for a Class B digital device, pursuant to part 15 of the FCC rules.

These limits are designed to provide reasonable protection against harmful interference in a residential installation. This equipment generates, uses and can radiate radio frequency energy and, if not installed and used in accordance with the instructions, may cause harmful interference to radio communications. However, there is no guarantee that interference will not occur in a particular installation.

If this equipment does cause harmful interference to radio or television reception, which can be determined by turning the equipment off and on, the user is encouraged to try to correct the interference by one or more of the following measures:

- Reorientation or relocation of the receiving antenna
  - Increase the separation between the equipment and receiver
  - Connect the equipment into an outlet on a circuit different from that to which the receiver is connected
  - Consult the dealer or an experienced radio/TV technician for help
- To assure continued compliance, any changes or modifications not expressly approved by the party.

Responsible for compliance could void the user's authority to operate this equipment. (Example - use only shielded interface cables when connecting to computer or peripheral devices)

This equipment complies with Part 15 of the FCC Rules.

Operation is subject to the following two conditions:

- (1) This device may not cause harmful interference, and
- (2) This device must accept any interference received, including interference that may cause undesired operation.

FCC Radiation Exposure Statement:

The equipment complies with FCC Radiation exposure limits set forth for uncontrolled environment. In order to avoid the possibility of exceeding the FCC radio frequency exposure limits, human proximity to the antenna shall not be less than 20cm during normal operation.

FCC ID: 2ASAQ-S21C

# Congratulations!

Your camera is ready to use. Thank you for choosing blurams.



blurams Facebook



blurams Instagram

[support@blurams.com](mailto:support@blurams.com)

[www.blurams.com](http://www.blurams.com)